

FACEPLATES

Electric strikes

Type	Faceplate	Color	Reversible	DIN Left	DIN Right	BASIC	SYMMETRIC	MINI	LATCH	GUIDE	SECURITY	HIGH SECURITY	WATERPROOF	FIRE	EMERGENCY	ARMoured	
Short	01	Grey	•			•	•										
	02	Grey	•				•										
	27	SST	•					•	•								
	28	SST	•					•	•								
	61	SST	•			•	•				•	•		•			
	62	SST	•				•										
	66	SST	•			•					•	•		•			
	76	SST	•										•				
	92	SST	•					•					•				
Boxes	80	Grey	•			•											
	81	Grey	•			•	•										
	82	Black	•												•		
	84	Grey Chrome Brass	•			•	•										
	86	Black Chrome	•													•	
C86 (6 unit accessory for box 86)																	
Long	03	Grey Brown	•			•											
	04	Grey Brown	•			•	•										
	05	Grey Brown	•			•	•										
	20	SST			•	•	•										
	21	SST		•		•	•										
	22	SST			•			•	•								
	23	SST		•				•	•								
	26	SST	•					•	•								
	29	SST	•					•	•								
	30	SST	•					•	•								
	38	SST	•						•								
	39	SST	•						•								
	43	SST	•				•				•	•			•		
	60	SST	•														•
	63	SST	•				•					•					
	64	SST	•				•	•									
	65	SST	•				•	•									
	67	SST	•				•				•	•			•		
	68	SST	•											•			
	69	SST	•											•			
	70	SST	•														•
	71	SST	•					•							•		
	73	SST			•		•	•									
	74	SST		•			•	•									
	75	SST	•											•			
	C63	SST	•				•						•				
	C64	SST	•				•	•									
	C65	SST	•				•	•									
	D3	Grey Brown	•				•										
	D4	Grey Brown	•				•	•									
Angled	08	Brown			•	•	•										
	09	Brown		•		•	•										
	10	Brown			•	•											
	11	Brown		•		•	•										
	12	Brown			•	•	•										
	13	Brown		•		•	•										
	14	Brown			•	•											
	15	Brown		•		•											
	16	Brown	•			•	•				•	•					
	17	Brown	•			•	•				•	•					
	24	SST			•				•								
	25	SST		•					•								
	45	Brown			•						•	•					
	48	Brown		•							•	•					
	49	SST			•						•	•					
	50	SST		•							•	•					

SHORT

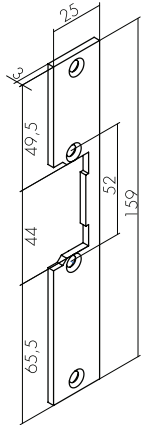

Reversible

01 GREY

61 SST
3mm

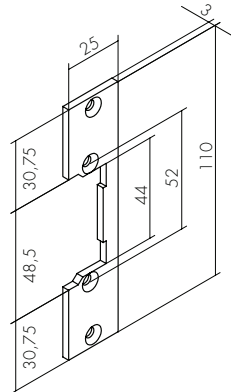

Reversible

02 GREY

62 SST
3mm

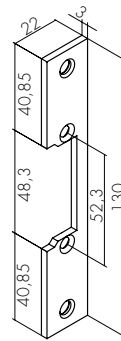

Reversible

27 SST
3mm

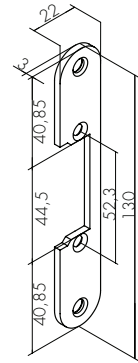

Reversible

28 SST
3mm

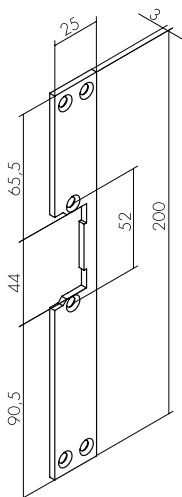

Reversible

66 SST
3mm

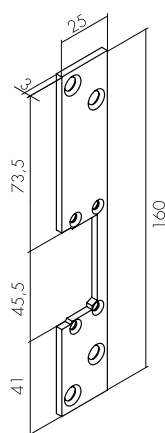

Reversible

76 SST
3mm

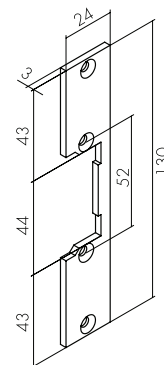

Reversible

92 SST
3mm

BOXES

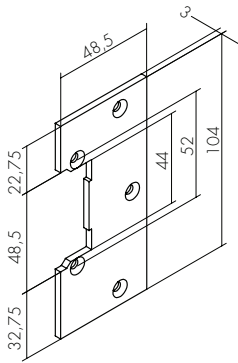

Reversible

80 GREY

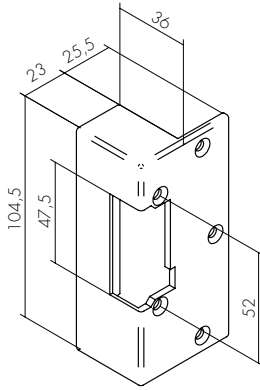

Reversible

81 GREY

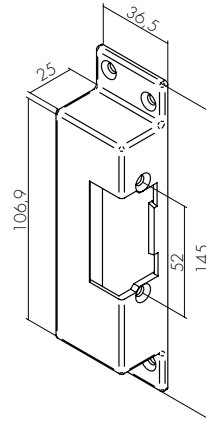

Reversible

84 GREY
CHROME
BRASS

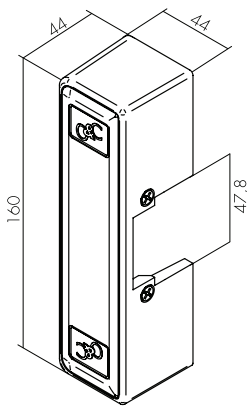

Reversible

82 BLACK

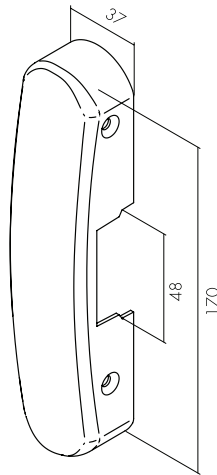

Reversible

86 BLACK + ANTIVANDAL + C86
CHROME BASE

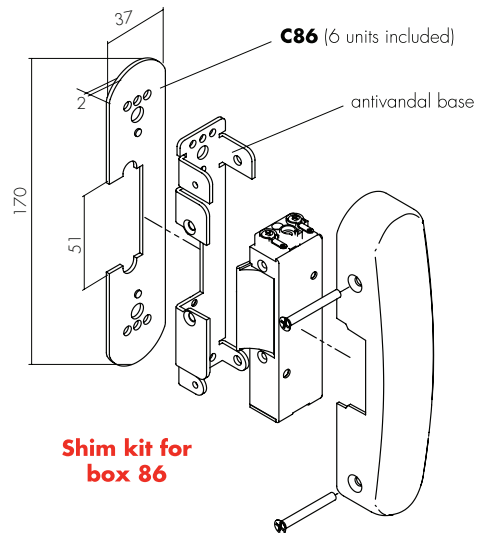

LONG

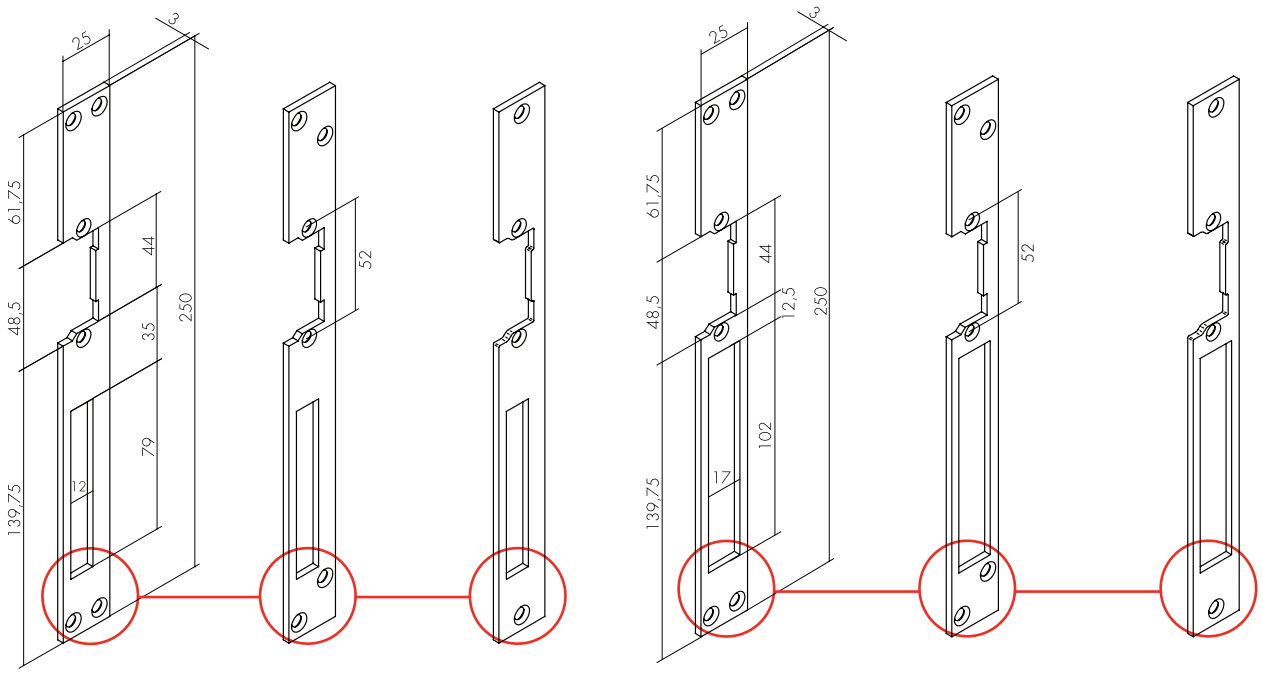

Reversible
03 GREY BROWN
Reversible
D3 GREY BROWN
Reversible
C63 SST 3mm
Reversible
04 GREY BROWN
Reversible
D4 GREY BROWN
Reversible
C64 SST 3mm
63 SST 3mm
64 SST 3mm

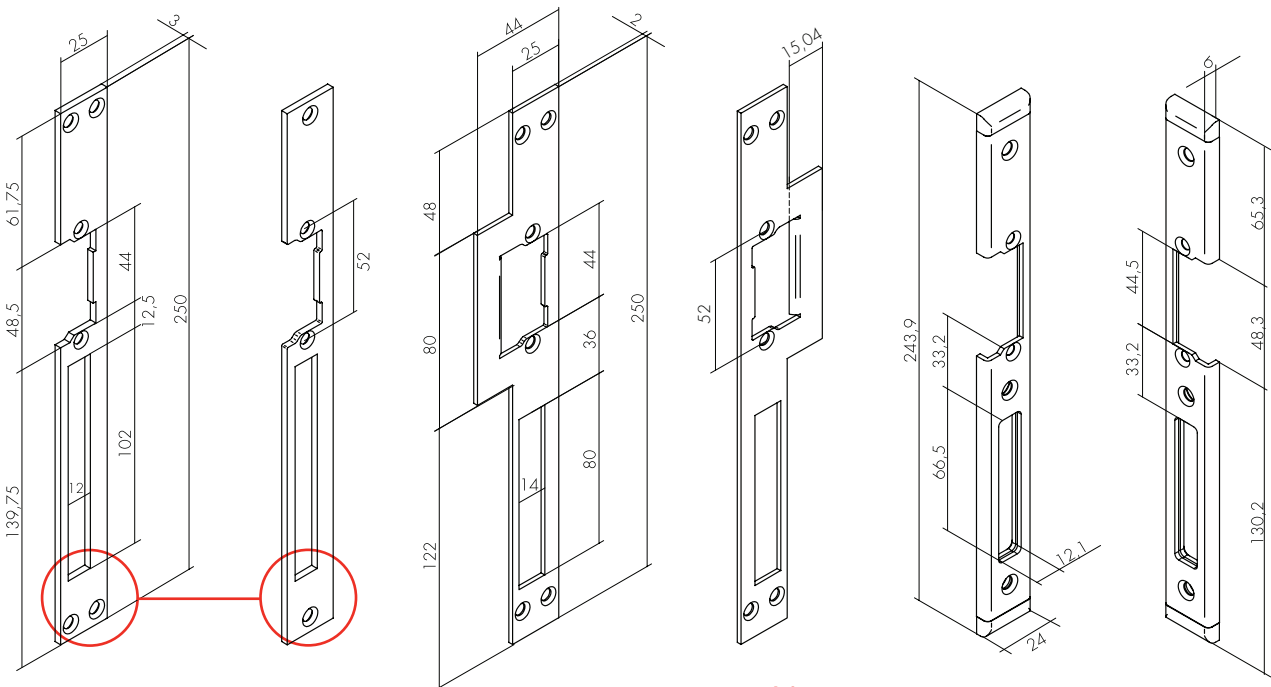

Reversible
05 GREY BROWN
Reversible
C65 SST 3mm
DIN Right
20 SST 2mm
DIN left
21 SST 2mm
DIN Right
22 SST 3mm
DIN Left
23 SST 3mm
65 SST 3mm

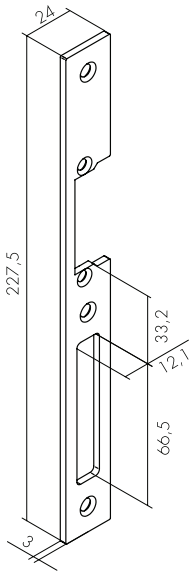

Reversible

26 SST
3mm

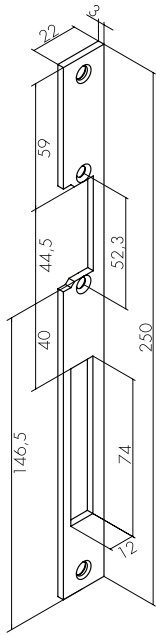

Reversible

29 SST
3mm

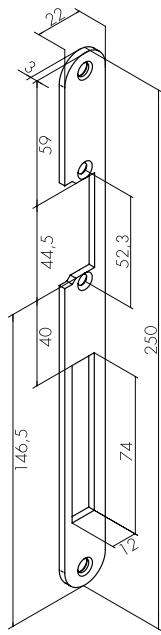

Reversible

30 SST
3mm

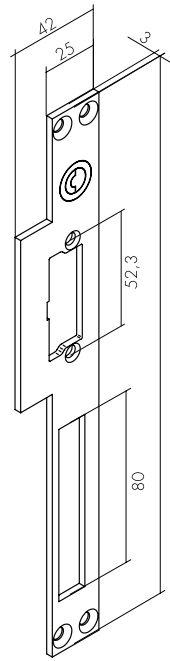

DIN Right

38 SST
3mm

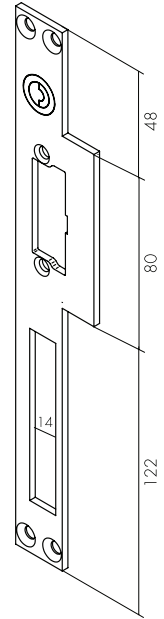

DIN Left

39 SST
3mm

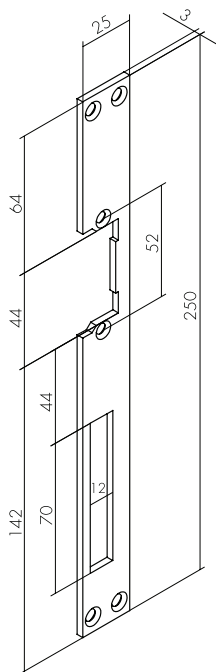

Reversible

43 SST
3mm

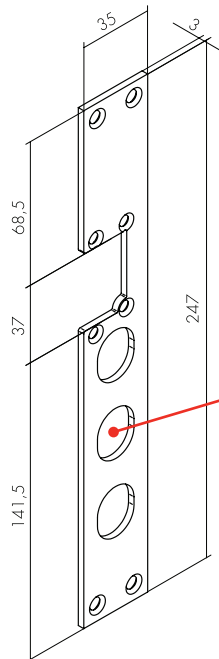

Reversible

60 SST
3mm

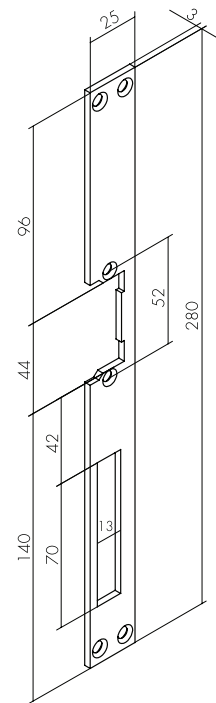
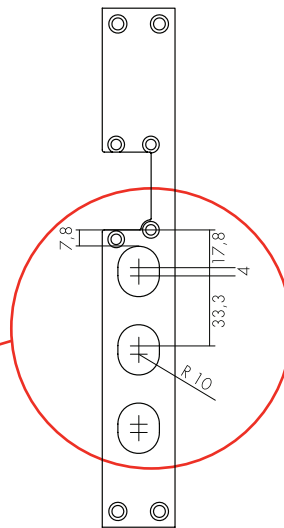

Reversible

67 SST
3mm

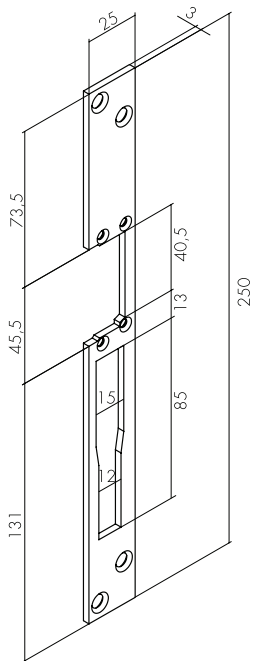

Reversible

68 SST
3mm

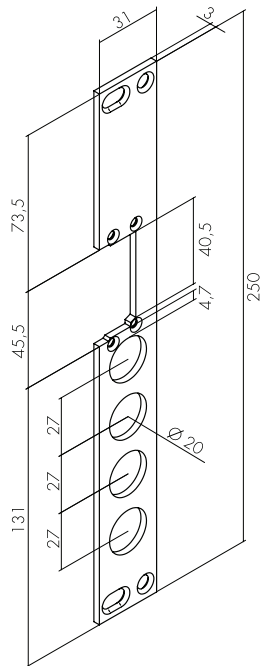

Reversible

69 SST
3mm

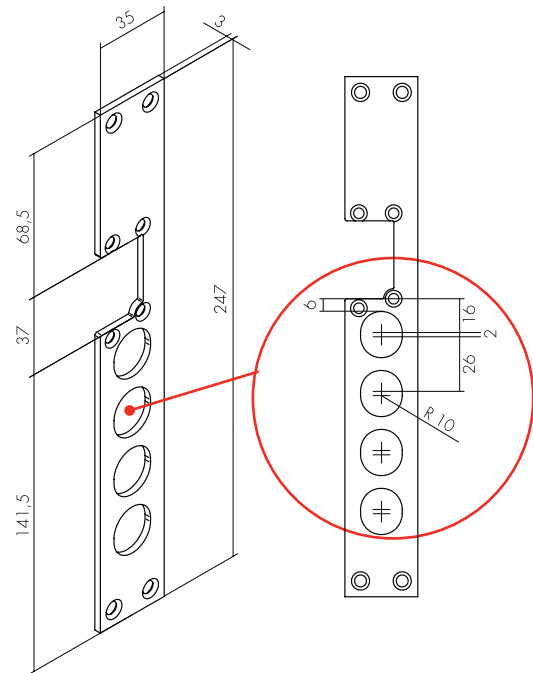

Reversible

70 SST
3mm

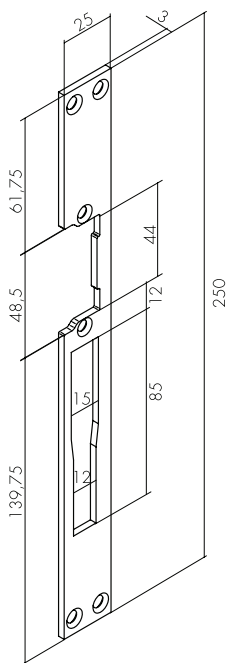

Reversible

71 SST
3mm

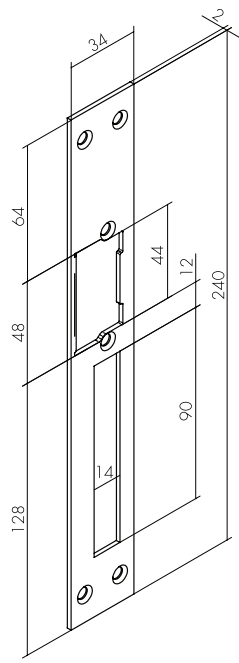

DIN Right

73 SST
2mm

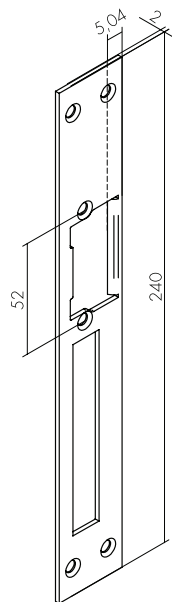

DIN Left

74 SST
2mm

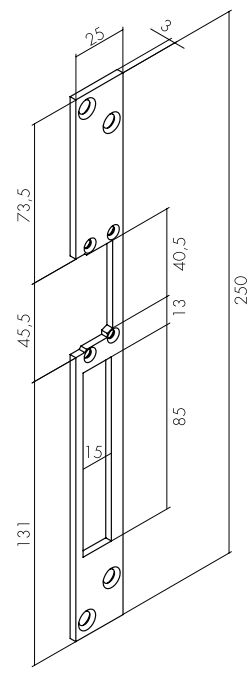

Reversible

75 SST
3mm

ANGLED

Electric strikes

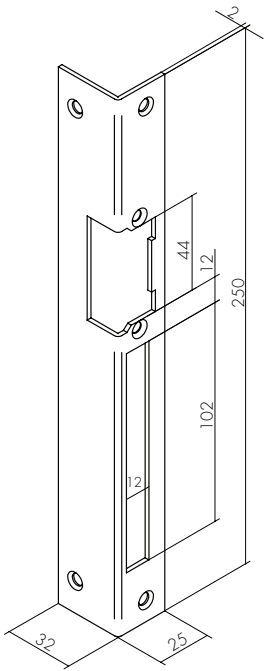

DIN Right
08 BROWN

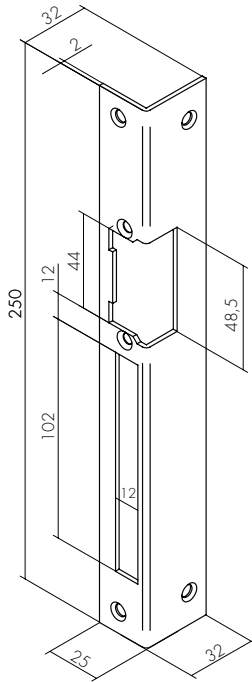

DIN Left
09 BROWN

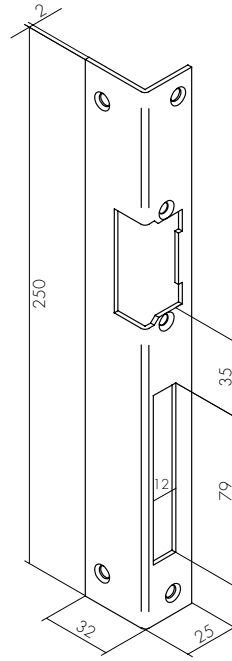

DIN Right
10 BROWN

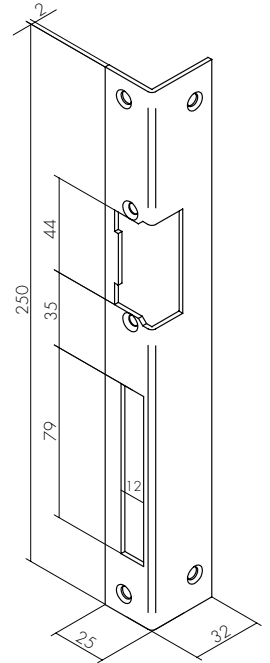

DIN Left
11 BROWN

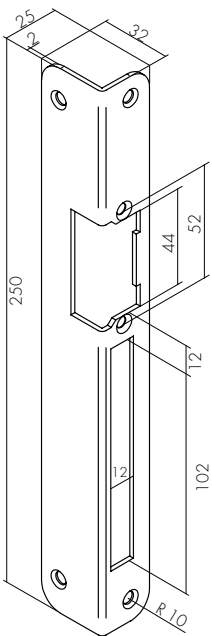

DIN Right
12 BROWN

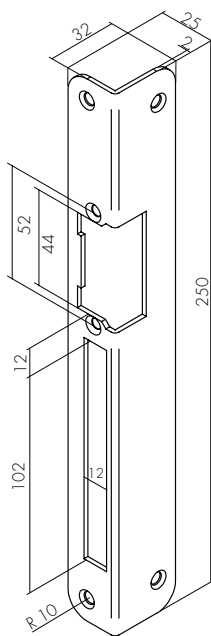

DIN Left
13 BROWN

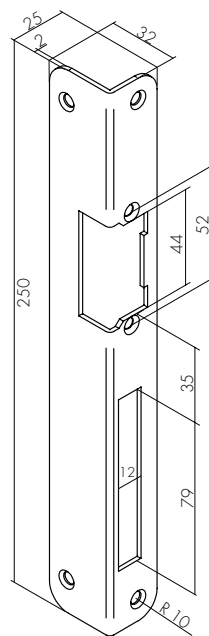

DIN Right
14 BROWN

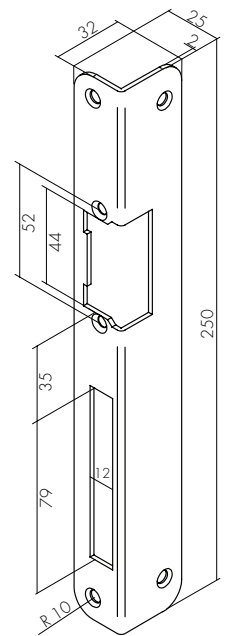

DIN Left
15 BROWN

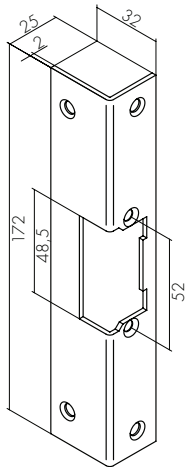

Reversible

16 BROWN

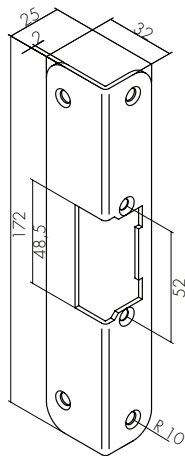

Reversible

17 BROWN

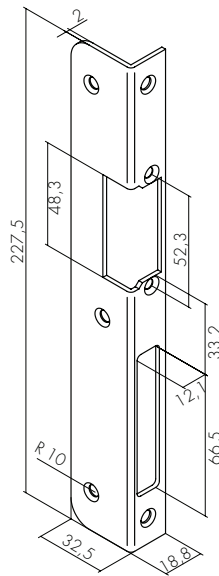

DIN Right

24 SST 2mm

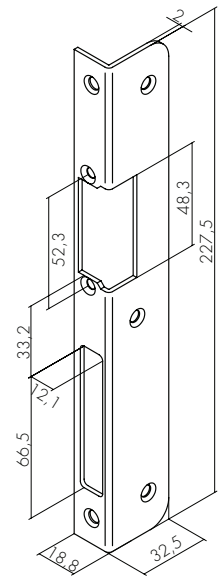

DIN Left

25 SST 2mm

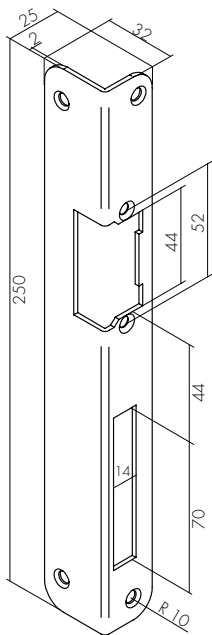

DIN Right

45 BROWN

49 SST 2mm

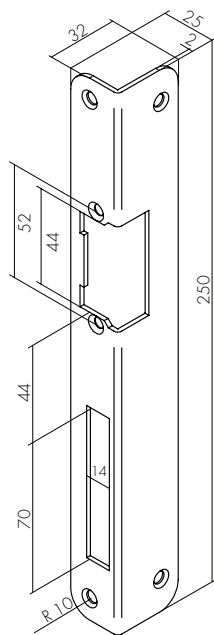

DIN Left

48 BROWN

50 SST 2mm

DUMMY

During construction works, it is recommended to install a provisional keeper behind the faceplate that will house the electric strike. This will keep the door closed during works and prevent deterioration (or theft) of high-valuable electric strikes.

CSR 001